



ASSEMBLY GUIDE

THANK YOU

Thanks for shopping with Shelving Inc. If you have any questions, comments, or concerns, please contact us:

Toll Free: 1-800-637-9508 | **Local/International:** 248-852-8600

Email: Support@shelving.com | **Live Chat:** Shelving.com

BEFORE GETTING STARTED

1. Lay out all of your parts to take inventory of your goods
2. If you notice something damaged or missing, call us
3. Assemble on a flat surface

ACCESSORIES

Accessories that require shelf clips have to be attached as you assemble your unit. Add casters by laying the assembled shelf on its side, unscrew the leveling feet and insert the casters.

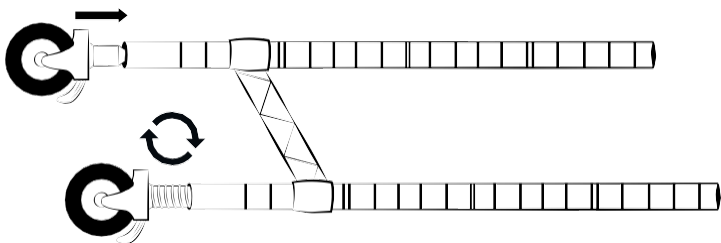

INSIDE YOUR BOX

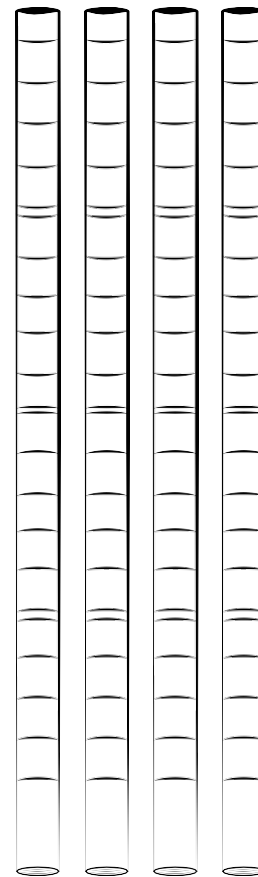

4 POSTS

*Posts 64" and taller come in two pieces.

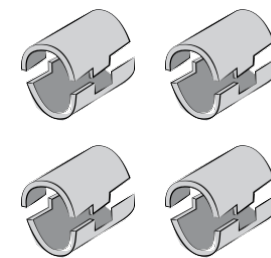

4 PLASTIC CLIPS

per shelf

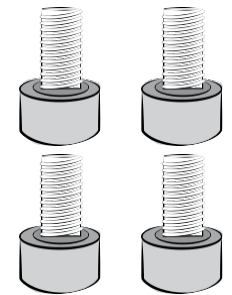

4 LEVELING FEET

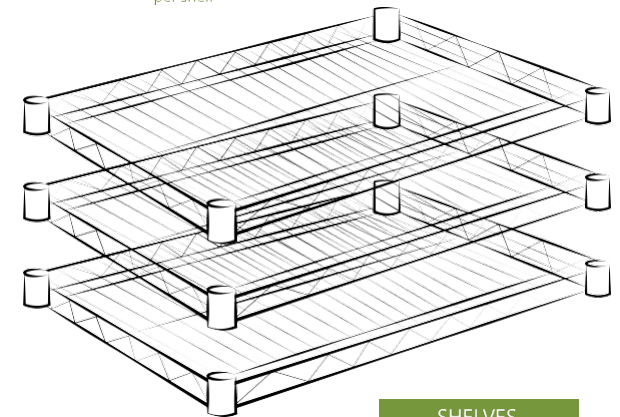

SHELVES

*Shelves are separated with black plastic rings for padding during shipping. Please discard; they are not needed for shelf assembly.

how to assemble WIRE SHELVING

ORDER MULTIPLE ITEMS? Look for an orange sticker on your package that reads "mixed merchandise." This indicates that multiple parts are included in your package. Otherwise, you'll receive another package soon.

- 01** Screw leveling feet into the bottom of each post.

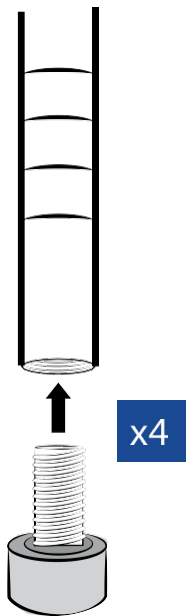

- 02** Snap clips onto posts where you want your bottom shelf to be located. Count notches on each post to ensure clips are level.

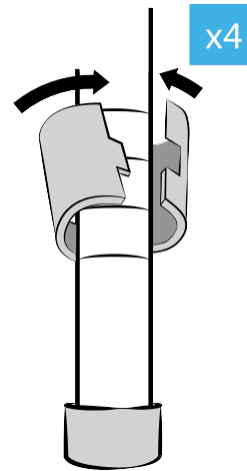

- 03** Turn bottom shelf on its side and insert posts through corners. Flip the shelving unit upright and tap corners to make sure it's snugly in place.

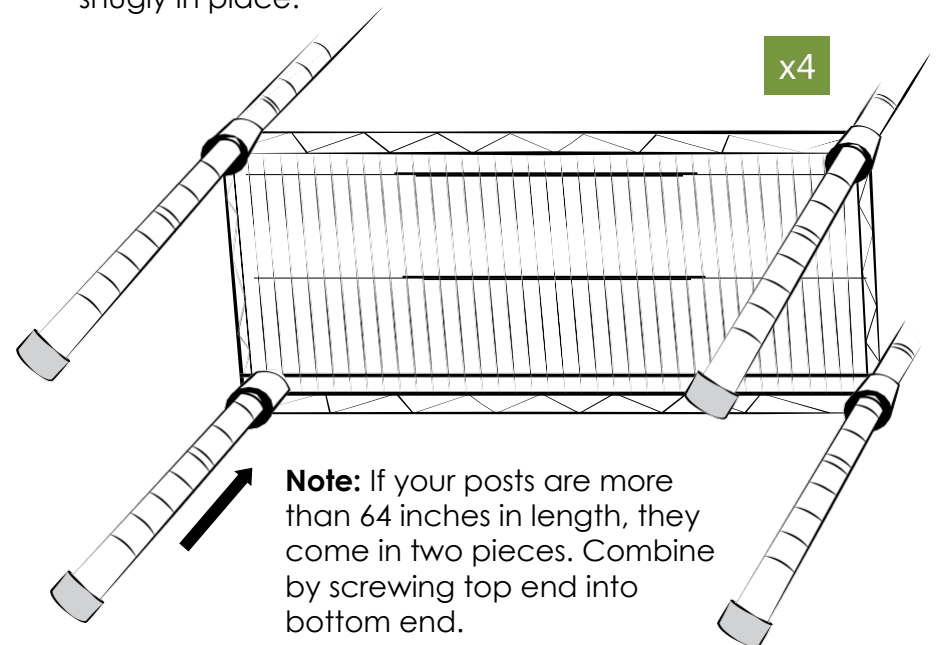

- 04** Add clips where you want your next shelf to be located and lower it into place.

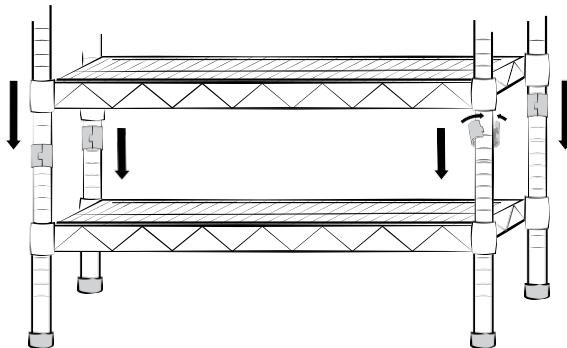

- 05** Repeat the instructions from step 4 for all remaining shelves.

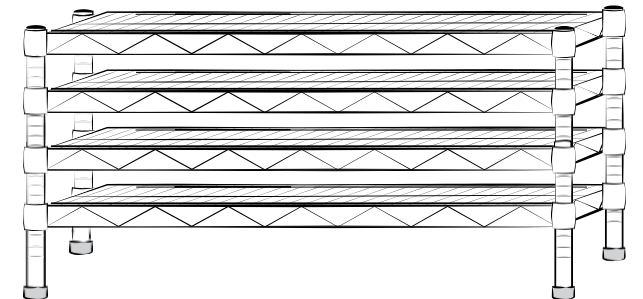

*Shelves are separated with black plastic rings for padding during shipping. Please discard.